

BLDG-A

BLDG-B



BLDG-C

BLDG-D

PAVING REBAR LAYOUT
 SCALE: 1/20"=1'-0"
 SDR: C-11.1 & C-11.2

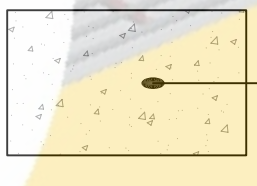
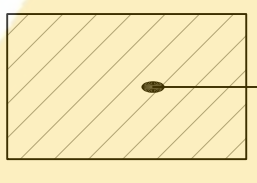
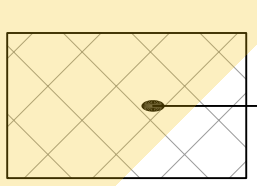

- 
 6" CONC. PAVING
 AREA = 52,930 SQ.FT.
 #4 @ 4'-0" @ 2'-0" EW
 FIELD CUT
- 
 8" CONC. PAVING
 AREA = 45,069 SQ.FT.
 #4 @ 4'-0" @ 18" EW
 FIELD CUT
- 
 10" CONC. PAVING
 AREA = 11,663 SQ.FT.
 #4 @ 4'-0" @ 15" EW
 FIELD CUT

-  TYPE 'E' - EXPANSION JOINT
-  TYPE 'C' - CONSTRUCTION JOINT
-  TYPE 'B' - BUTT JOINT

ONCE REBAR SERVICES

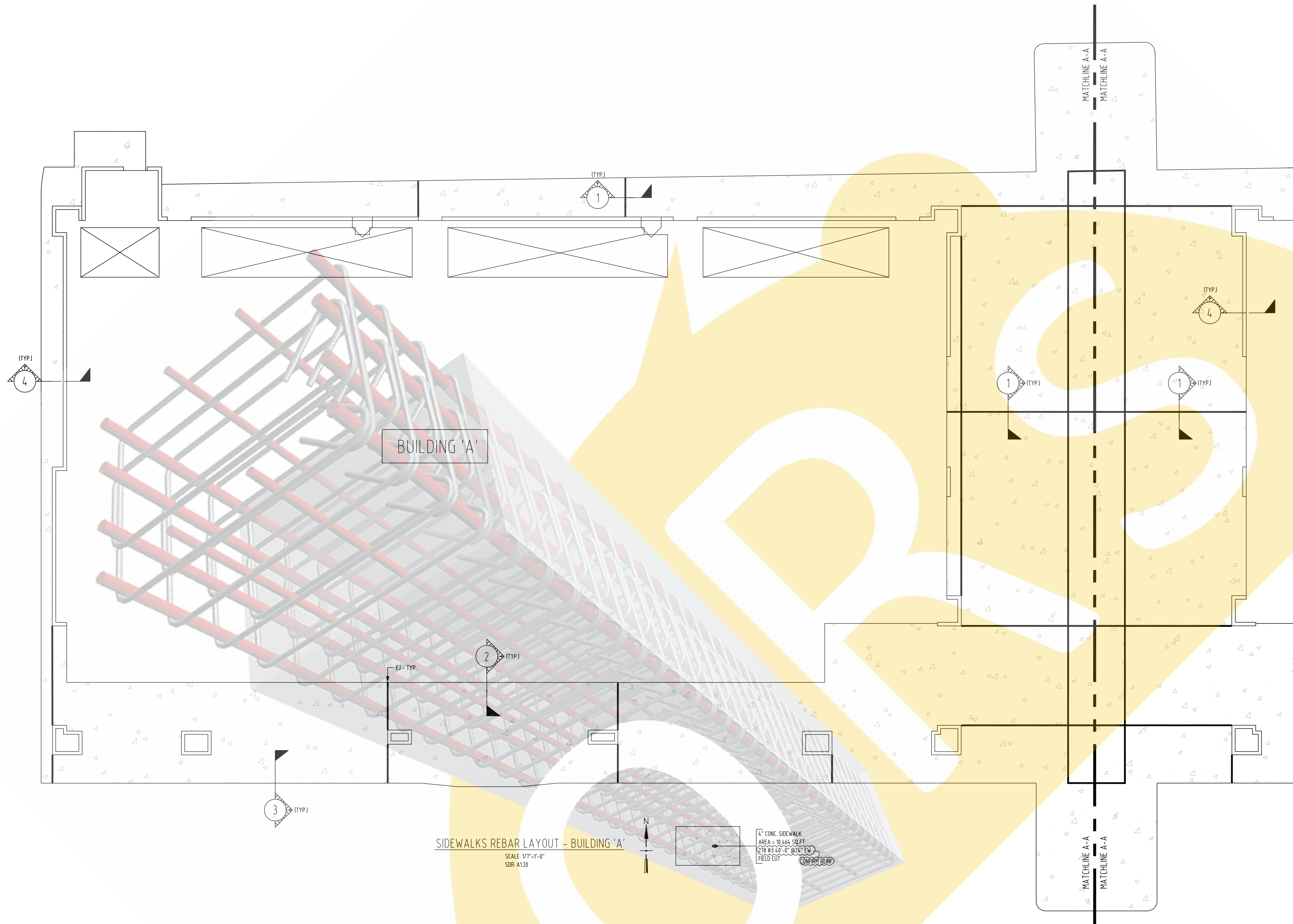

SIDEWALKS REBAR LAYOUT - BUILDING 'A'
 SCALE: 1/4"=1'-0"
 SDR: A120

4" CONC. SIDEWALK
 AREA = 30,464 SQ.FT.
 6" @ 18" O.C. 6" CONC. EW
 FIELD OUT
 CONFORM REBAR

ONCE REBAR SERVICES

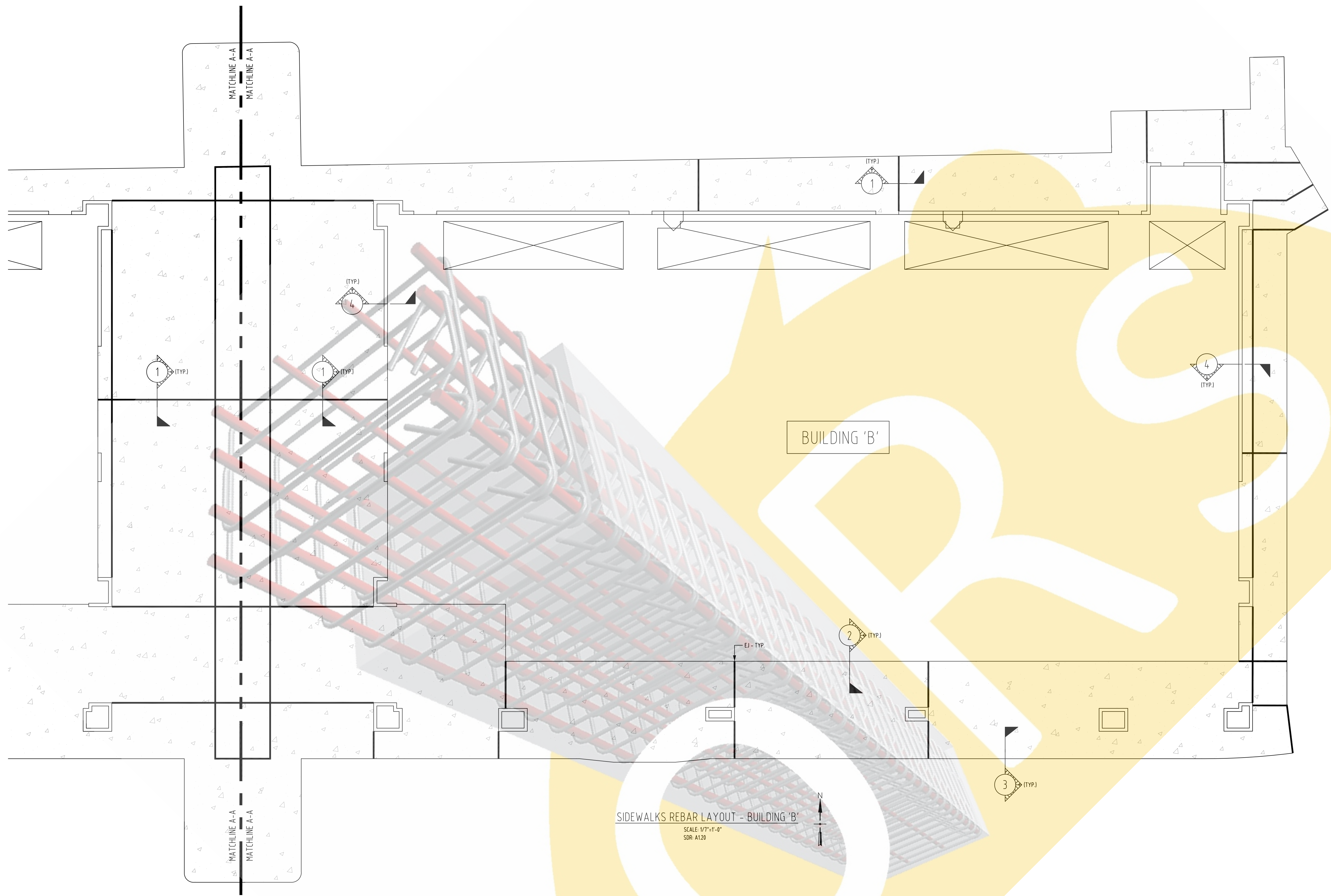

ONCE REBAR SERVICES

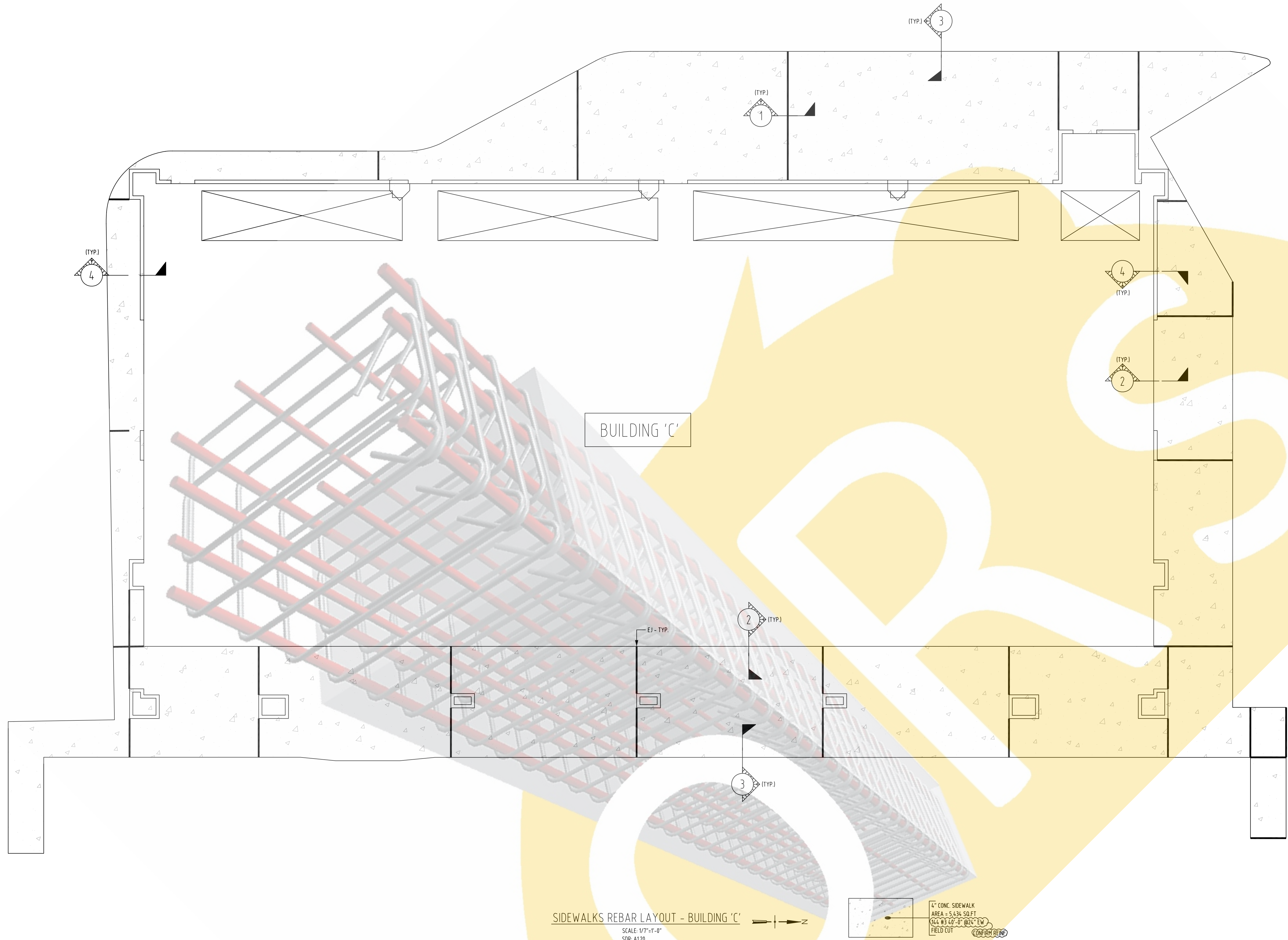

BUILDING 'C'

SIDEWALKS REBAR LAYOUT - BUILDING 'C'
 SCALE: 1/7"=1'-0"
 SDR: A120

4" CONC. SIDEWALK
 AREA - 5.53K SQ FT
 ALL 03 02 01 02 03 04 05 06 07 08 09 10 11 12
 FIELD CUT

ONCE REBAR SERVICES

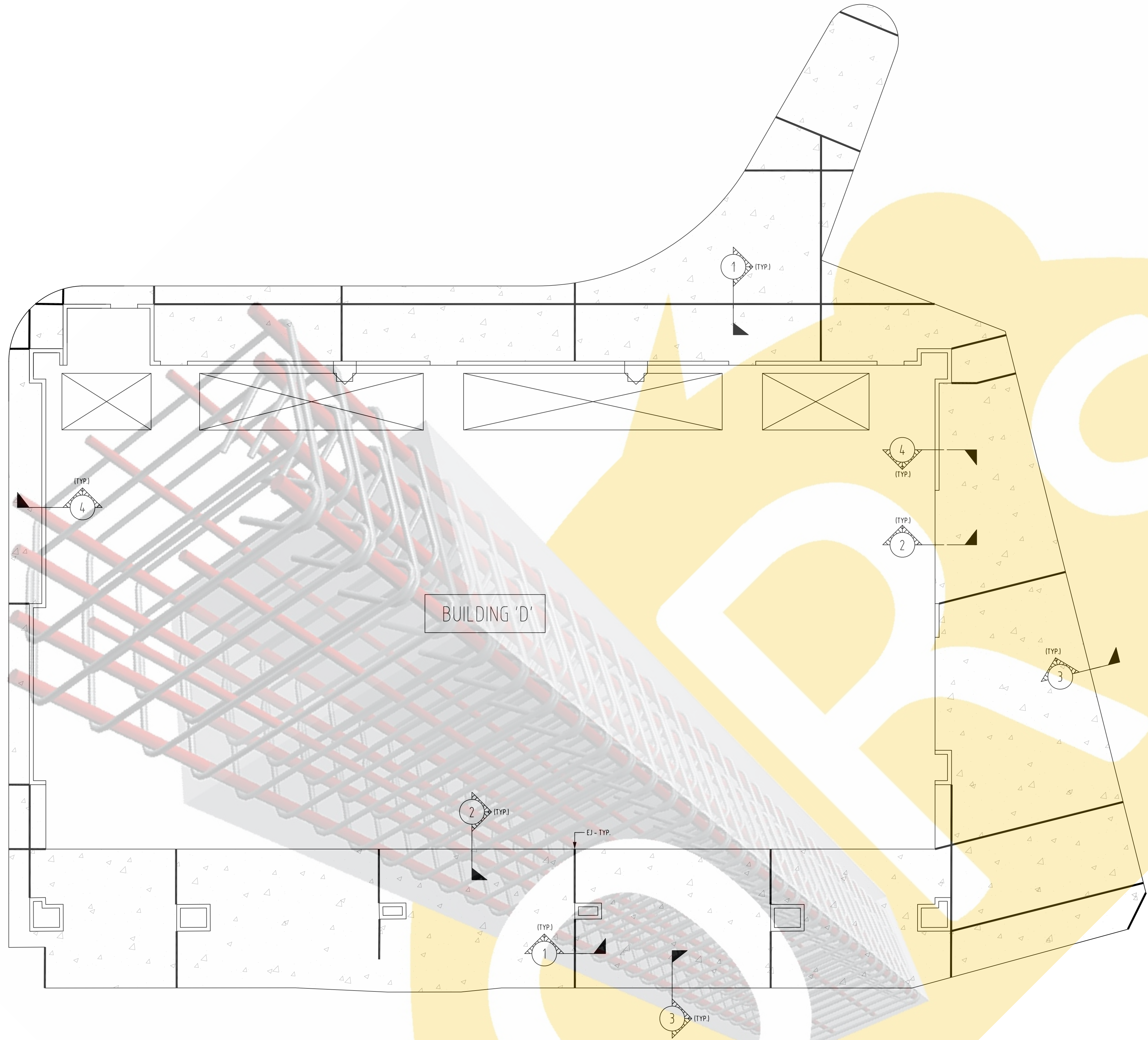

BUILDING 'D'

SIDEWALKS REBAR LAYOUT - BUILDING 'D'

SCALE: 1/4"=1'-0"
SDR: A120

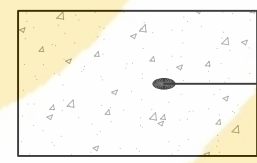
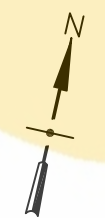

4" CONC. SIDEWALK
AREA = 4,931 SQ. FT.
@ 18" OC. @ 0.06" EW
FIELD OUT



ONCE REBAR SERVICES

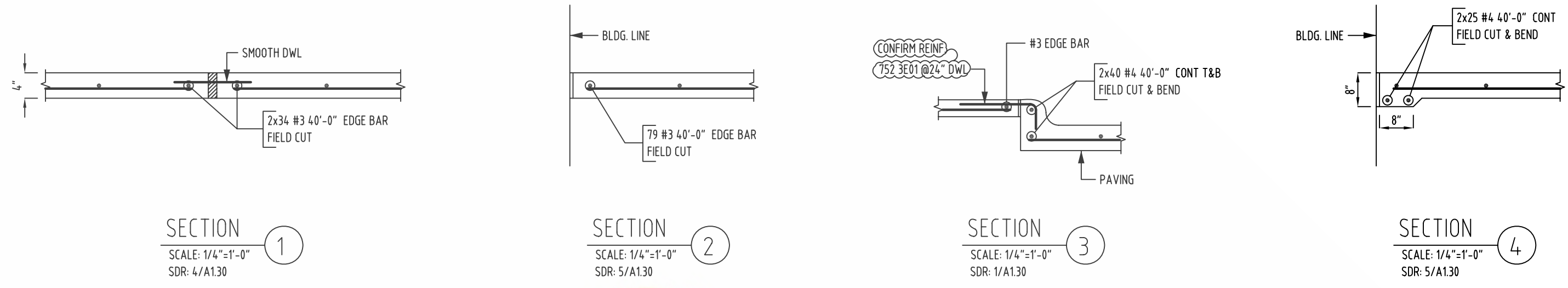
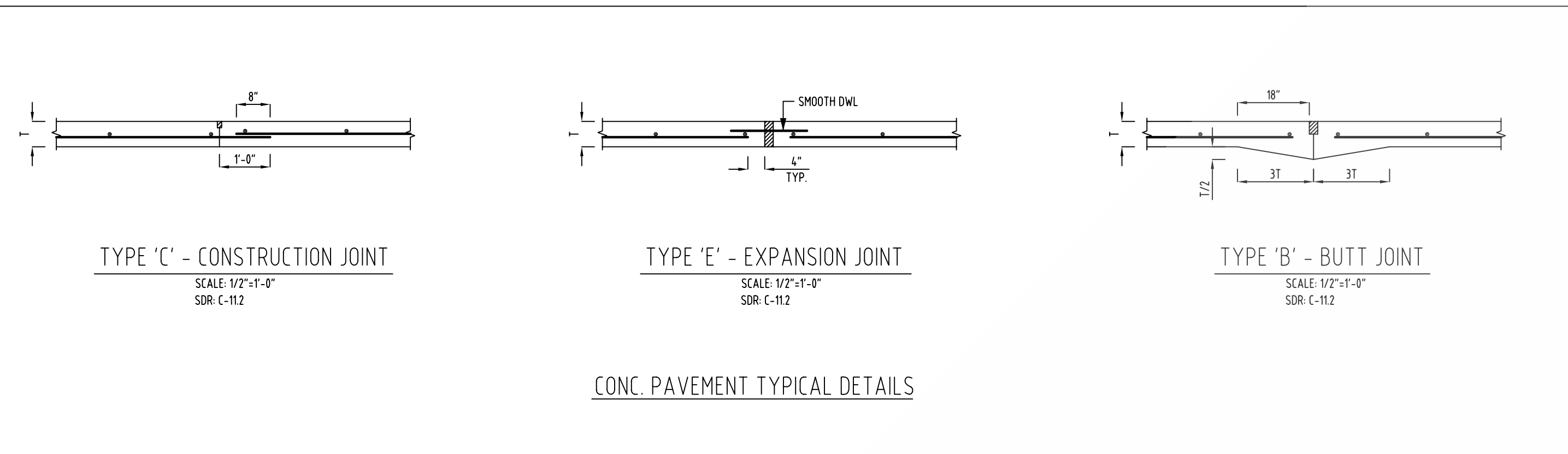

Release Number: R5.01-R5.06

BENDING DETAILS

Bar Mark	Qty	Size	Total Length	Type	'A'	'B'	'C'	'D'	'E'	'F'	'G'	'H'	'J'	'K'	'O'	'R'
3E01	752	#3	2'-0"	17		1'-6"	0'-6"									

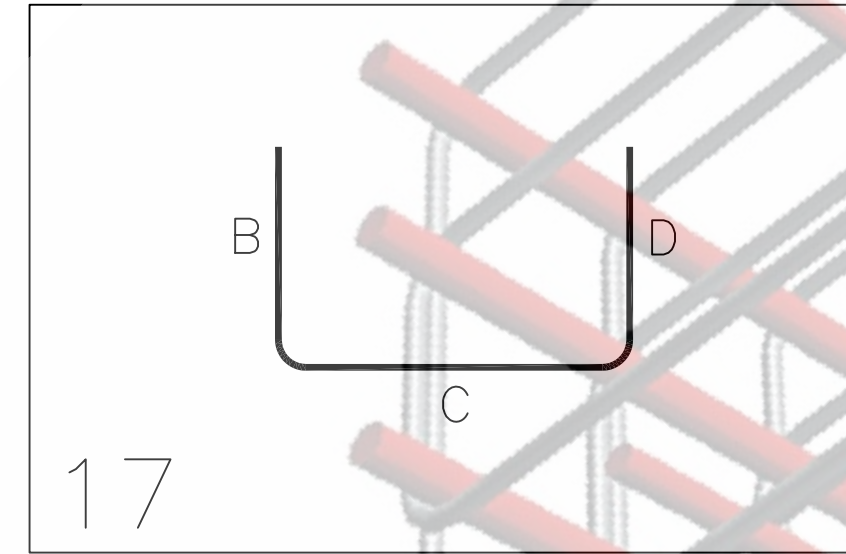

ACCESSORIES

ELEMENTS	DESCRIPTION	SQ.FT\LFT\NOS	NOS/LFT
6" CONC. PAVING	2 1/2" PLASTIC PAVING CHAIRS @48" O.C	52,930 SQ.FT	3310 NOS
8" CONC. PAVING	3 1/2" PLASTIC PAVING CHAIRS @48" O.C	45,069 SQ.FT	2817 NOS
10" CONC. PAVING	4 1/2" PLASTIC PAVING CHAIRS @48" O.C	11,663 SQ.FT	729 NOS
4" CONC. SIDEWALK	1 1/4" PLASTIC PAVING CHAIRS @48" O.C	20,829 SQ.FT	1302 NOS

ONCE REBAR SERVICES